



FRANKLIN COUNTY BOARD OF COMMISSIONERS

Monday February 4, 2019
Hamilton Hobgood Courthouse Annex
113 South Main Street
Louisburg, NC

6:55 P.M. - Season of Prayer - Commissioner Sidney Dunston

7:00 P.M. - Official Meeting Begins - Call to Order

Pledge of Allegiance

ITEM 1. CONSENT AGENDA

- A. Budget Ordinance Amendment #5 (Pursuant to North Carolina General Statute 159-15, the County Finance Officer is requesting a budget ordinance amendment in amount of \$66,601 for the fiscal year ending June 30, 2019 to amend the General Fund to recognize Board action from previous meetings, additional funding for the Health Department from the Division of Public Health, recognize insurance payments for damage at the Airport and pay the 2018 property taxes to Kerr Tar.)
- B. Approval of fees for Radiological Testing Services
- C. Annual Report of Unpaid Taxes that are liens on Real Property

ITEM 2. COMMENTS FROM THE PUBLIC

This is the time set aside by the Board of Commissioners to allow individuals five minutes to address the Board on issues concerning the county.

ITEM 3. PROCLAMATION IN HONOR OF FRANKLIN COUNTY'S 240TH ANNIVERSARY CELEBRATION

ACTION REQUESTED: Consider approval.

ITEM 4. RECOGNITION: HEALTH DEPARTMENT EMPLOYEE

Scott LaVigne, Health Director, will recognize Vicky Saleeby, Public Health Nurse III, for her work with staff from the Rand Corporation. As a result, the Rand Corporation and the Center for Medicare and Medicaid Services (CMS) recognized the Health Department with a certificate of participation and \$1600 for participation in the CMS IMPACT Act National Beta Testing.

ACTION REQUESTED: None.

ITEM 5. AUDIT PRESENTATION: 2017/2018 FISCAL YEAR

The Board will receive an audit presentation by Winston, Williams, Creech, Evans & Company, LLP. Finance Director Jamie Holtzman, will also make a presentation.

ACTION REQUESTED: None.

ITEM 6. COMPREHENSIVE PARKS AND RECREATION MASTER PLAN

Oliver Greene, Parks and Recreation Director, will provide the Board with an update on the Comprehensive Parks and Recreation Master Plan process. A resident survey is currently being conducted throughout the county.

ACTION REQUESTED: None.

ITEM 7. APPOINTMENTS

- Board of Health

The Board is asked to consider reappointing Dr. Cletus Simpson (Dentist) and Dr. Phillip Meador (Physician) for a three-year term.

The Board is also asked to consider appointing Dr. Jerry Ellington (Optometrist) for a three-year term.

ACTION REQUESTED: Consider approval.

ITEM 8. OTHER BUSINESS

ITEM 9. BOARD, MANAGER AND CLERK'S COMMENTS

This is the time set aside for the Board of County Commissioners, the County Manager, and the Clerk to the Board to report on various activities. The Board may also discuss other items of interest.

Franklin County Commissioner's Agenda Information Sheet

Requested Meeting Date: February 4, 2019

of attachment (s) _____

Item Title (as it should appear on the agenda): Budget Ordinance Amendment #5

Initiated by (Name, Job Title): Jamie Holtzman, Finance Director

Board action proposed: Approve and Chairman to sign

Is a public hearing needed? No

Has this item been reviewed by the appropriate staff? Please note all that apply.

County Manager _____

County Attorney _____

Finance Director X

Summary of Request:

To amend the General Fund to recognize BOARD action from previous meetings, additional funding for the Health Department from the Division of Public Health, recognize insurance payment for damages at the Airport, and pay the 2018 property taxes to Kerr-Tar.

FOR OFFICE USE ONLY:

APPROVED

DENIED

ACTION: _____

DATE: _____



County Of Franklin

113 Market Street
 Louisburg, North Carolina 27549
 Telephone: 919-496-3182
 Fax: 919-496-2683

Office of Finance
 Jamie Holtzman
 Director

BUDGET ORDINANCE AMENDMENT #5		
BE IT ORDAINED by the Board of Commissioners of the County of Franklin, North Carolina, that pursuant to North Carolina General Statutes 159-15, the following amendment be made to the annual budget ordinance for the fiscal year ending June 30, 2019		
Section 1. To amend the General Fund to recognize BOARD action from previous meetings, additional funding for the Health Department from the Division of Public Health, recognize insurance payments for damage at the Airport and pay the 2018 property taxes to Kerr-Tar.		
Expenditures	Account #	Amount of Increase
Building and Grounds-Airport	10-650-0150	924
Professional Services-Planning Dept	10-490-0040	16,450
Owens Park Project	43-535-0760	1,267
Clinical Health Budget	10-592-0000	20,757
Kerr Tar Tax Incentive	10-580-0540	27,203
	Total	\$ 66,601
=====		
Revenues	Account #	Amount of Increase
Proceeds from Insurance Claims	10-335-9901	924
Maternal Health Grant	10-379-0230	13,999
Child Health Grant	10-379-0235	6,758
Kerr Tar Hub Tax Revenue	10-389-0007	6,800
Fund Balance Fund 10 GF	10-399-0000	38,120
	Total	\$ 66,601
=====		
Section 2. Copies of this amendment shall be furnished to the Clerk of the Board of Commissioners, the Budget Officer, and the Finance Officer for their direction.		
Adopted this 4th day of February 2019.		
Chairman of the Board of County Commissioners		

Franklin County Commissioner's Agenda Information Sheet

Requested Meeting Date:

of attachment (s) 1

Item Title (as it should appear on the agenda): **Board of Health Adopts fees for Radiological Testing Services**

Initiated by (Name, Job Title): **Scott LaVigne, Health Director**

Board action proposed: **Approval of Recommended Fees**

Is a public hearing needed? **No.**

Has this item been reviewed by the appropriate staff? Please note all that apply.

County Manager _____ County Attorney _____ Finance Director _____

Summary of Request: **At their 1/8/19 meeting, the Franklin County Board of Health reviewed and approved fees for the Health Department's Environmental Health unit to offer Radiological Testing services for private well-water and indoor air. As these are new fees for new services, they require the approval of the Franklin County Board of Health and the Franklin County Board of Commissioners.**

FOR OFFICE USE ONLY:

- APPROVED
- DENIED

ACTION: _____ **DATE:** _____

Franklin County Board of Health

January 8, 2019

Environmental Health Uranium, Radon, and Groundwater Radiological sampling fee proposal

A bedrock formation under a sizeable portion of Franklin County may increase its citizen's risk of exposure to Uranium, radon, and other naturally occurring radiological contaminants. The Franklin County Health Department has implemented an outreach and education program concerning increased probability of these contaminants in this area and the health risk associated with human exposure.

As a part of the outreach program, the department would like to offer sampling/testing services for these contaminants. Having this service available through the department would provide a relatively low cost, easily accessible means for citizens to test for these environmental contaminants in their home and drinking water. Franklin County Environmental Health currently utilizes the NC state lab for most its water testing services. The state lab does not offer testing for these contaminants, so testing must be outsourced through private labs.

Service/Fee proposal:

- 1- Air and water Radon test kits are distributed to individuals, who collect and send the sample via US mail to Air-Chek Inc. Air Check reports results directly to the individual.
 - \$10.00/ air radon sample kit (HD cost \$8.00, \$17.00 retail)
 - \$25.00/ water radon sample kit (HD cost \$22.50, \$27.00 retail)
- 2- The department provides a drinking water sampling service and testing through Pace Analytical. An EH specialist would visit the home, collect the samples, and send the samples to Pace Analytical for processing. The report would be sent to the department for follow-up. An individual could request any or all the samples if desired.
 - \$50.00 Uranium (HD cost \$50.00)
 - \$50.00 Radon (HD cost \$50.00)
 - \$75.00 Gross Alpha & Beta (HD cost \$75.00)
 - \$50.00 Visit/Handling fee for sampling service (HD cost \$15.00 courier service)

Respectively submitted,

Jeffrey Wood

Environmental Health Program Coordinator



PROCLAMATION
IN HONOR OF FRANKLIN COUNTY'S 240TH ANNIVERSARY CELEBRATION

WHEREAS, an act dividing Bute County into Warren and Franklin County was introduced in the North Carolina General Assembly on January 20, 1779, passing both the House and the Senate on that day; and

WHEREAS, the act, after approval by both chambers, was ultimately ratified on February 12, 1779; and

WHEREAS, the County of Franklin was formed and Louisburg became the county seat with the original 100 acres; and

WHEREAS, in 2019, the County of Franklin will celebrate the 240th anniversary of the creation of Franklin County, and

WHEREAS, it is fitting and proper that the full year be commemorated with historical, educational, artistic and joyful events in keeping with this rare and important anniversary; and

WHEREAS, this year-long event should reach out to and connect with the people, places, and faces of the county's diverse population and geography; and

WHEREAS, county organizations and groups from all sectors should be encouraged to join in and be part of this celebration;

NOW, THEREFORE, the Franklin County Board of Commissioners does proclaim that during 2019, municipal governments, educational institutions, businesses and individuals be encouraged to shape their activities to help celebrate our anniversary by reflecting on Franklin County's history and by looking to the future to see what we will accomplish in the years ahead.

This the 4th day of February, 2019.

Kristen G. King, Clerk to the Board

Sidney E. Dunston, Chairman

Franklin County Commissioner's Agenda Information Sheet

Requested Meeting Date:

of attachment (s) 2

Item Title (as it should appear on the agenda): **Franklin County Home Health Agency Employee Recognized**

Initiated by (Name, Job Title): **Scott LaVigne, Health Director**

Board action proposed: **Recognition of Health Department Employee.**

Is a public hearing needed? **No.**

Has this item been reviewed by the appropriate staff? Please note all that apply.

County Manager _____ County Attorney _____ Finance Director _____

Summary of Request: The Health Department's Home Health Agency participated in the Center for Medicare and Medicaid Services (CMS) IMPACT Act National Beta Testing, as a contributing post-acute care provider test site. Vicky Saleeby, Public Health Nurse III, worked with staff from the Rand Corporation to review the impact of proposed national changes to home health BEFORE they were adopted. Vicky Saleeby's work on this project was recognized by Rand Corporation staff as being exemplary in her professionalism and dedication to ensuring these proposed changes would be reviewed for their impact on smaller, rural agencies. As a result, the Franklin County Health Department was recognized by the Rand Corporation and CMS with a Certificate of Appreciation and a total of \$1,600 for our participation. We wish to recognize and thank Vicky for bringing this honor to our Home Health Agency.

FOR OFFICE USE ONLY:

- APPROVED
- DENIED

ACTION: _____ **DATE:** _____



October 2018

To the Staff and Leadership at Franklin County Health Department:

On behalf of the RAND Corporation and the Centers for Medicare and Medicaid Services (CMS), we are writing to express our sincere appreciation for your recent involvement in the IMPACT Act National Beta Test as a contributing post-acute care provider and test site. Your site's participation and staff commitment to this important work was crucial to the success of the project and has contributed greatly to our understanding of the assessment data elements under consideration. We are especially grateful for your added contribution during our extended data collection period June 1st through August 15th, 2018.

Findings from this phase of our project will be used by CMS to inform decision making regarding the cross-setting standardization of post-acute care patient assessment data elements and their implementation into practice.

A few housekeeping items:

1. The full report of results from this National Beta Test will be posted on the CMS IMPACT Act webpage. We plan to acknowledge each participating beta test post-acute care provider as contributing to the data collection effort. If you do not want your facility/agency listed, please let us know by emailing: impactupdate@rand.org and we will leave your facility/agency name out of the public report.
2. We are also working on providing site-specific beta test data to participating providers. Please note that these materials are still in process and not currently available. However, if you are interested in accessing your site's beta test data in the future, please email: impactupdate@rand.org and include your site name. We will respond with updated information about the status of these materials and the timing and process for accessing these data.

Dedicated individuals like you make this project possible. We are grateful for your participation.

Sincerely,

Charlayne Van-Skinner, JD

Maria Orlando Edelen, PhD
RAND-IMPACT Project Director
RAND Corporation
20 Park Plaza Suite 920
Boston MA 02116
(617) 338.2059 x8634
orlando@rand.org

Charlayne Van-Skinner, JD
Sr. Health Policy Analyst
Contracting Officer's Representative
Centers for Medicare and Medicaid Services

RESEARCH AREAS
Children and Families
Education and the Arts
Energy and Environment
Health and Health Care
Infrastructure and Transportation
International Affairs
Law and Business
National Security
Population and Aging
Public Safety
Science and Technology
Terrorism and Homeland Security

OFFICES

Santa Monica, CA
Washington, DC
Pittsburgh, PA
New Orleans, LA
Boston, MA
Cambridge, UK
Brussels, BE
Canberra, AU

www.rand.org

Certificate of Appreciation

Franklin County Health
Department

In recognition of your participation in the
IMPACT ACT STANDARDIZED PATIENT ASSESSMENT DATA PROJECT
National Beta Test
2017-2018

Thank you for your important contribution.



Maria Orlando Edelen, PhD
RAND-IMPACT Project Director
Senior Behavioral Scientist, RAND Corporation

Franklin County Commissioner's Agenda Information Sheet

Requested Meeting Date: February 4, 2019

of attachment (s) _____

Item Title (as it should appear on the agenda): Fiscal Year 2017/2018 Audit Presentation

Initiated by (Name, Job Title): Jamie Holtzman, Finance Director

Board action proposed: Information only

Is a public hearing needed? No

Has this item been reviewed by the appropriate staff? Please note all that apply.

County Manager _____

County Attorney _____

Finance Director X

Summary of Request:

Tara Roberson from Winston, Williams, Creech, Evans, & Company, LLP will present the 2017/2018 Audit. After her presentation I will make a presentation with additional information about the audit.

FOR OFFICE USE ONLY:

APPROVED

DENIED

ACTION: _____

DATE: _____

Franklin County
June 30, 2018

Audit Presentation

Winston, Williams, Creech, Evans & Co.
LLP



Overview

- ◆ Franklin County has received an unmodified opinion on their June 30, 2018 financial statements; this is also called a “clean” opinion.
- ◆ Franklin County again received the Certificate of Excellence in Financial Reporting for fiscal year 06/30/17 and has submitted the 6/30/18 report to GFOA.

Governmental Fund Revenues

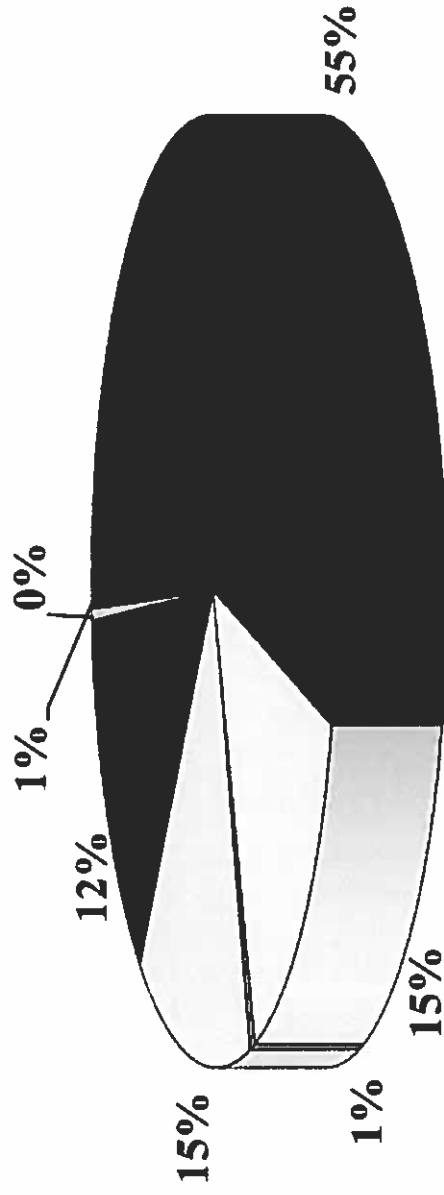

- Ad Valorem Taxes
- Sales Tax
- Other Taxes & licenses
- Restricted Intergovernmental
- Fees, Sales and Charges
- Investment Earnings
- Miscellaneous

Governmental Fund Expenditures

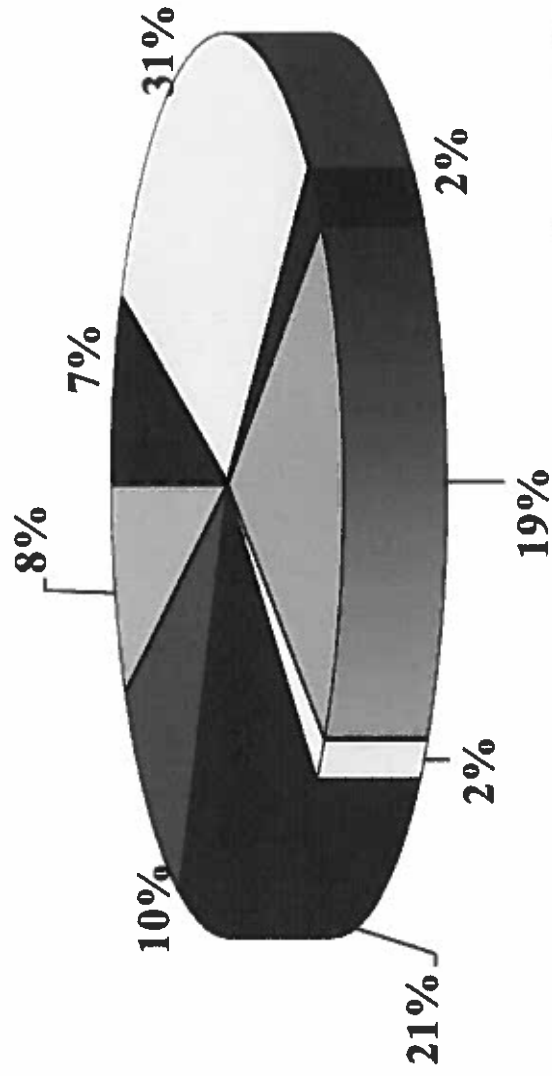

■ General Government

■ Economic & Physical Development

□ Cultural & Recreational

■ Debt Service

□ Public Safety

□ Human Services

■ Education

□ Capital Outlay

Cash-All Funds

(excludes Restricted Cash and Agency Fund Cash)

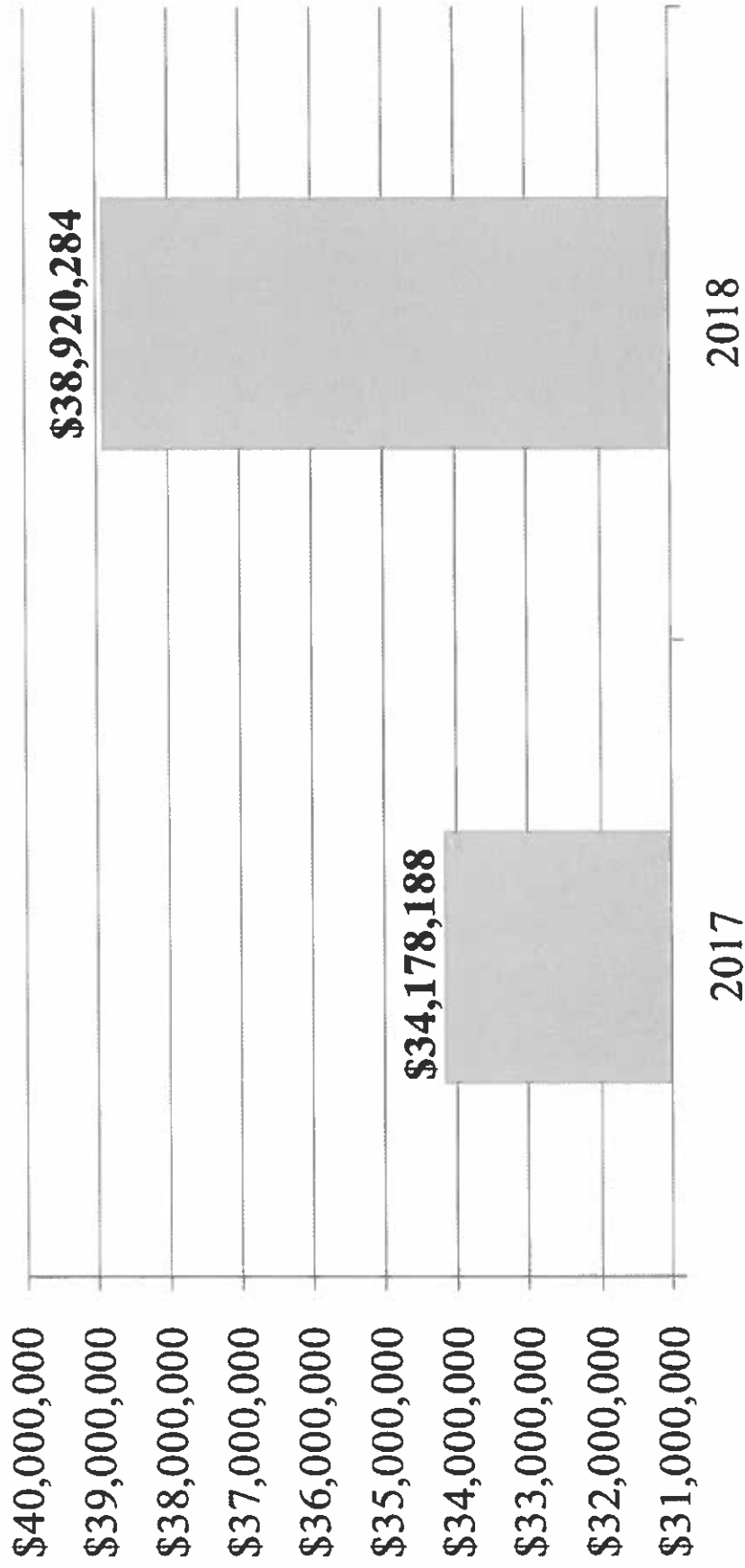

General Fund Revenues

(includes transfers & debt proceeds)

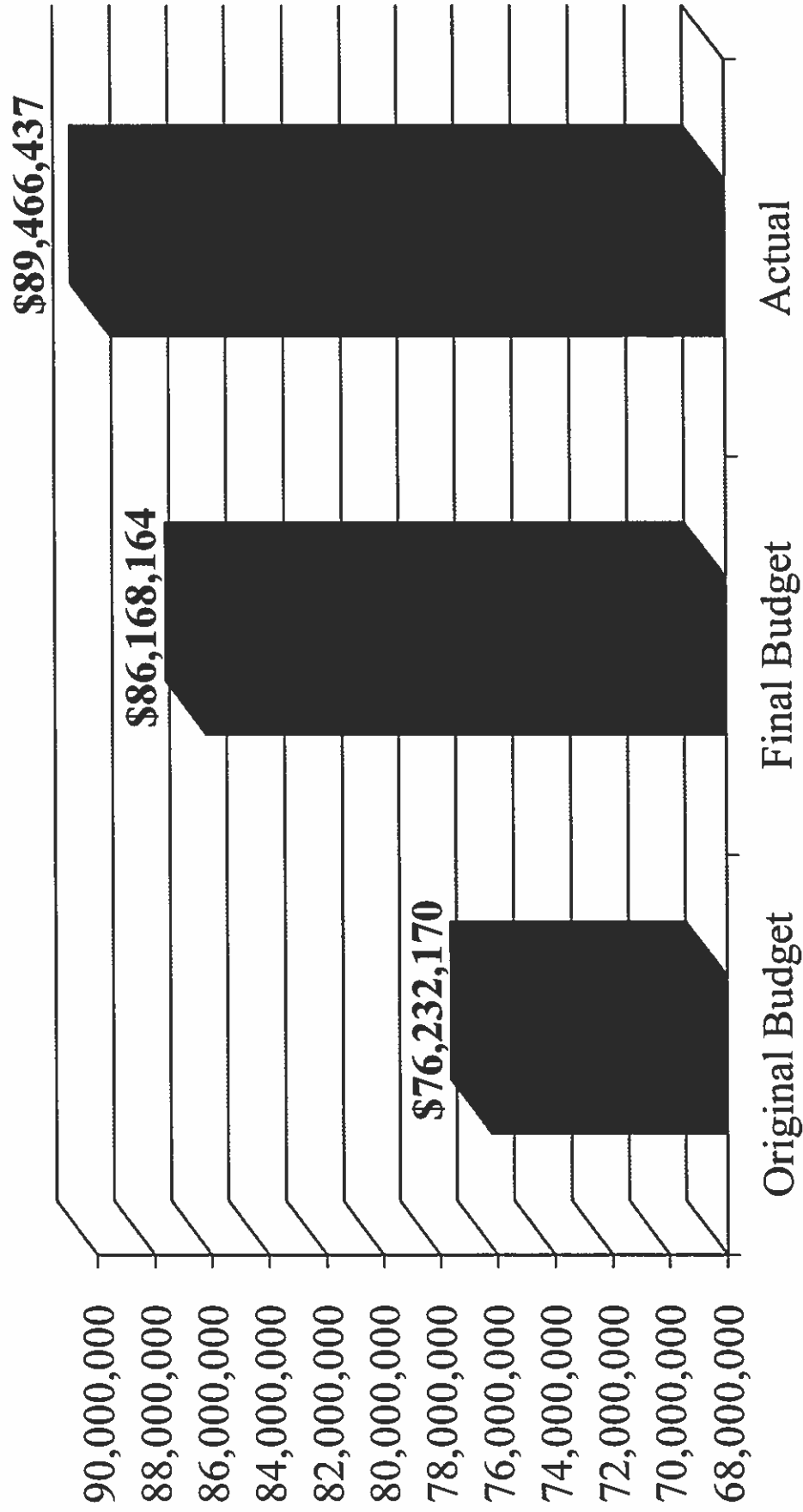



General Fund Expenditur

(includes transfers)

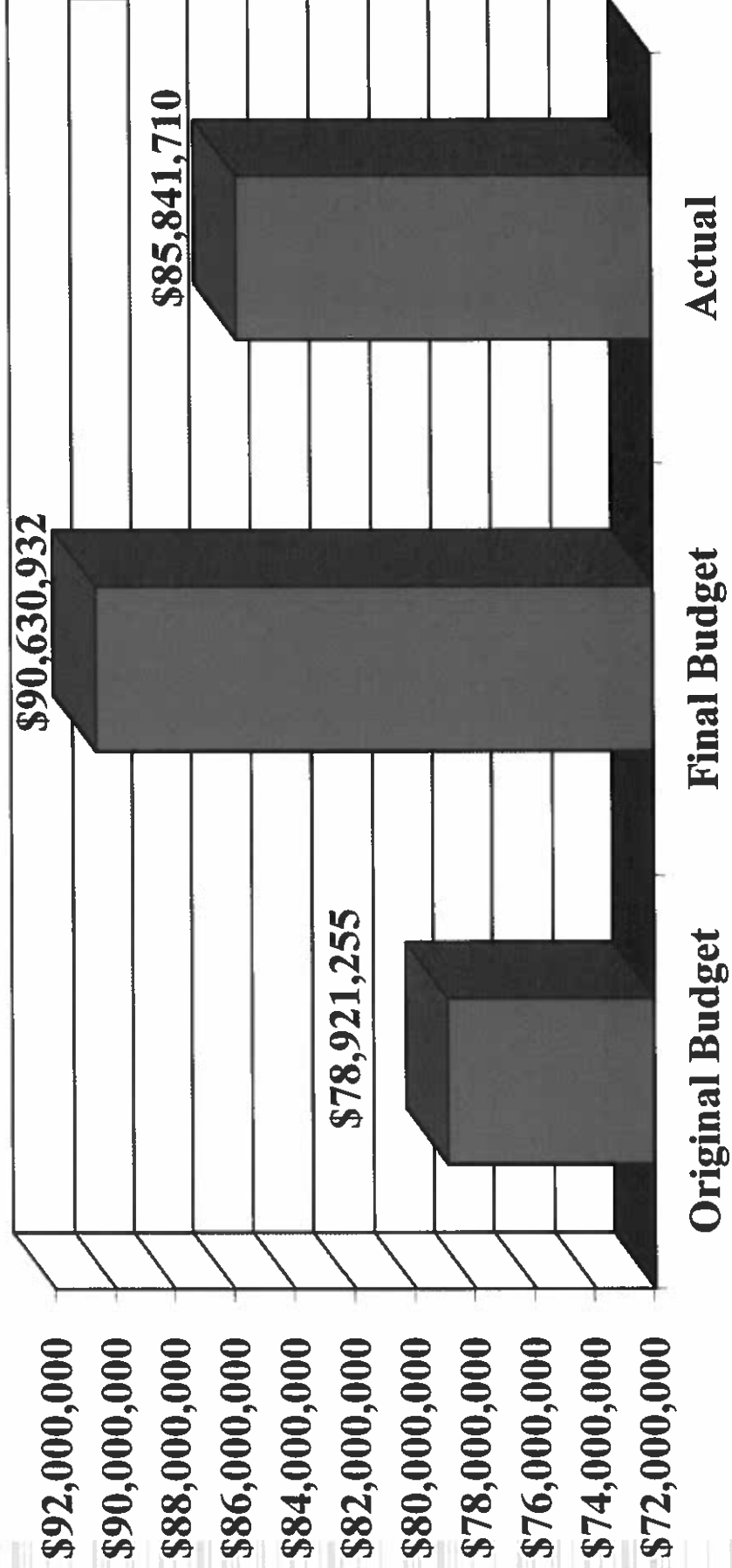

Appropriated Fund Balance

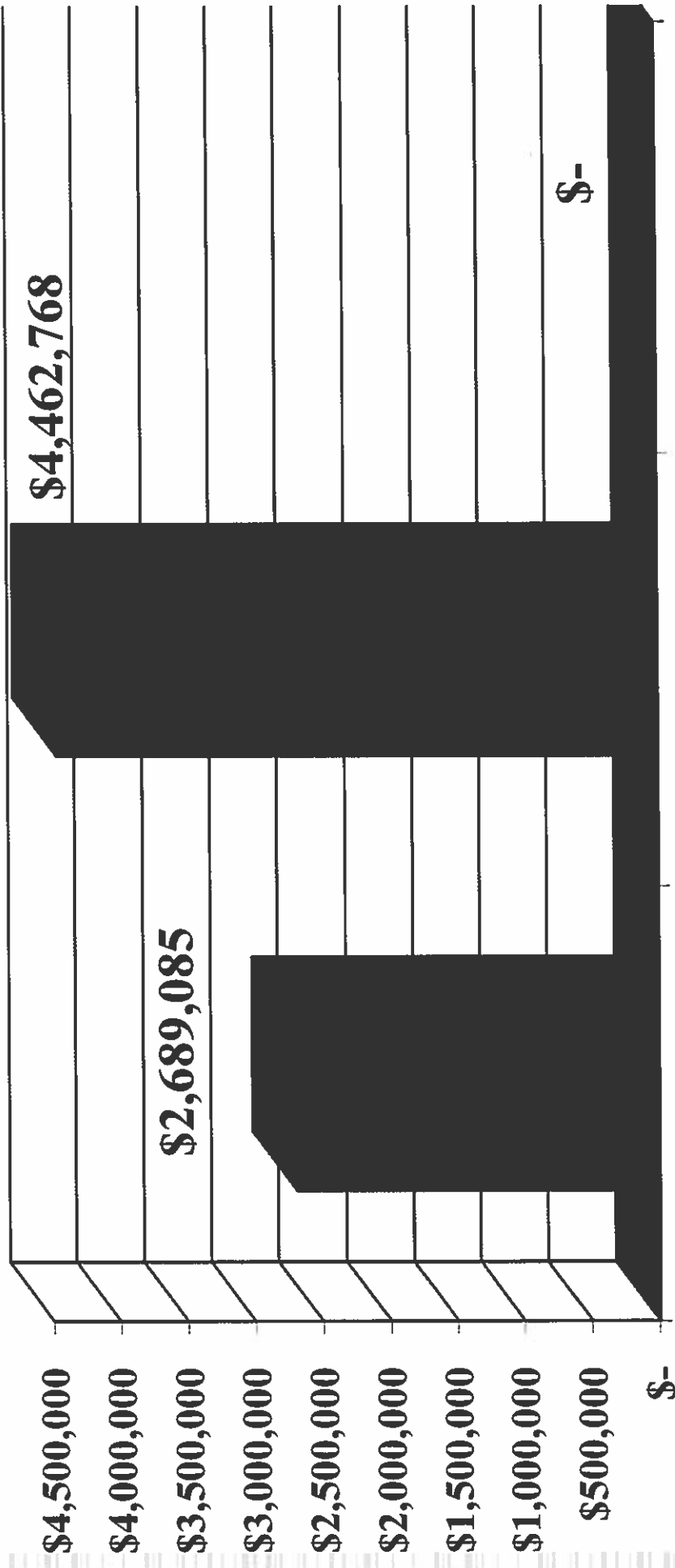

General Fund - Unassigned Fund Balance

	2017	2018
Unassigned Fund Balance Available for Appropriation	\$ 17,783,339	\$ 21,898,821
Expenditures (includes transfers)	83,093,451	77,078,520
Unassigned FBA as a % of Expenditures	21.40%	28.41%

General Fund - Fund Balance Available for Appropriation Statistics

	2017	2018
Fund Balance Available for Appropriation	\$ 25,536,446	\$ 29,004,741
Expenditures (includes transfers)	74,980,451	76,983,104
FBA as a % of Expenditures	34.06%	37.68%
Statewide Avg (per LGC statistics)	31.57%	33.44%

Adjusted Tax Levy

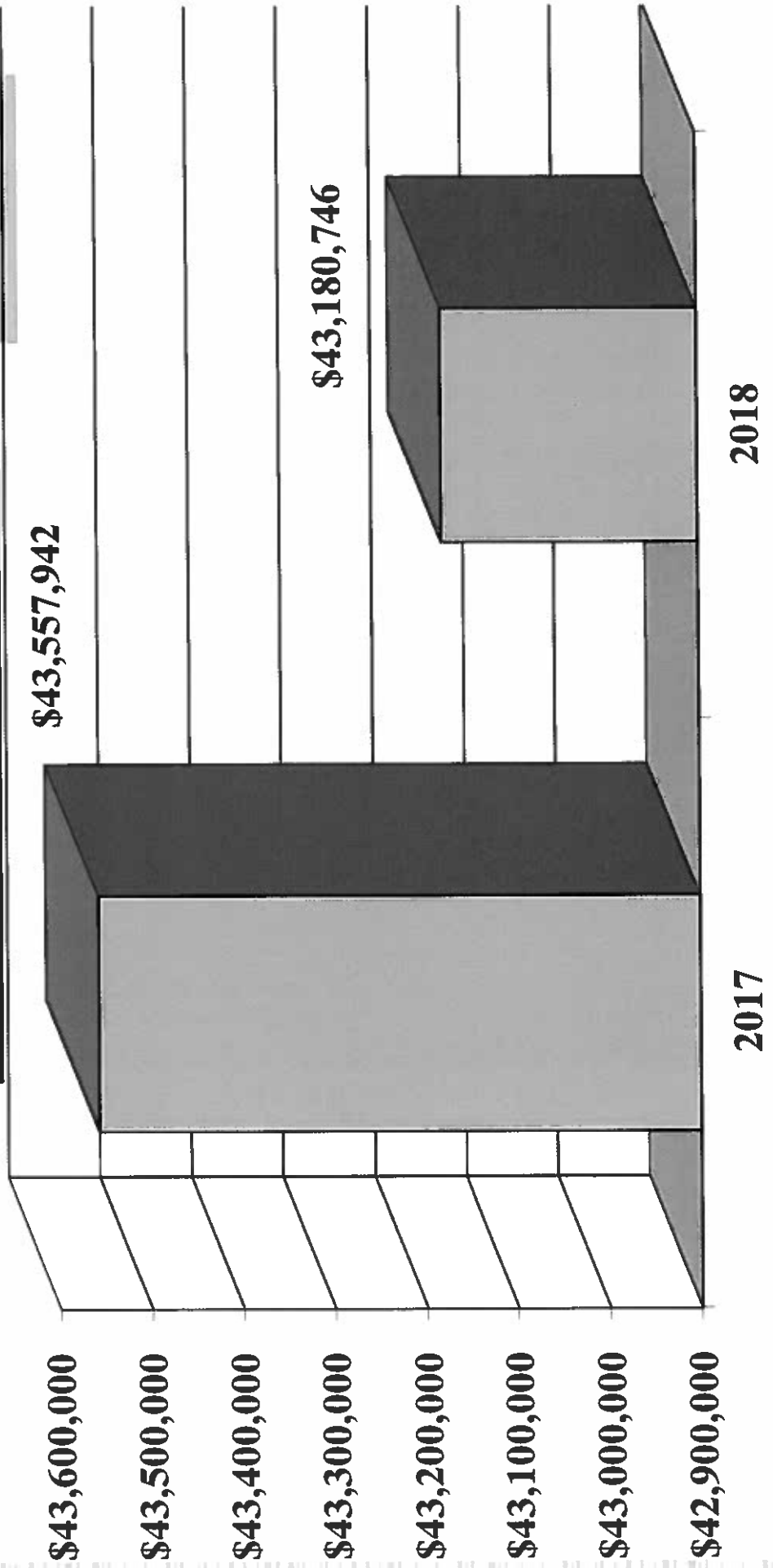

Tax Collection Percentages

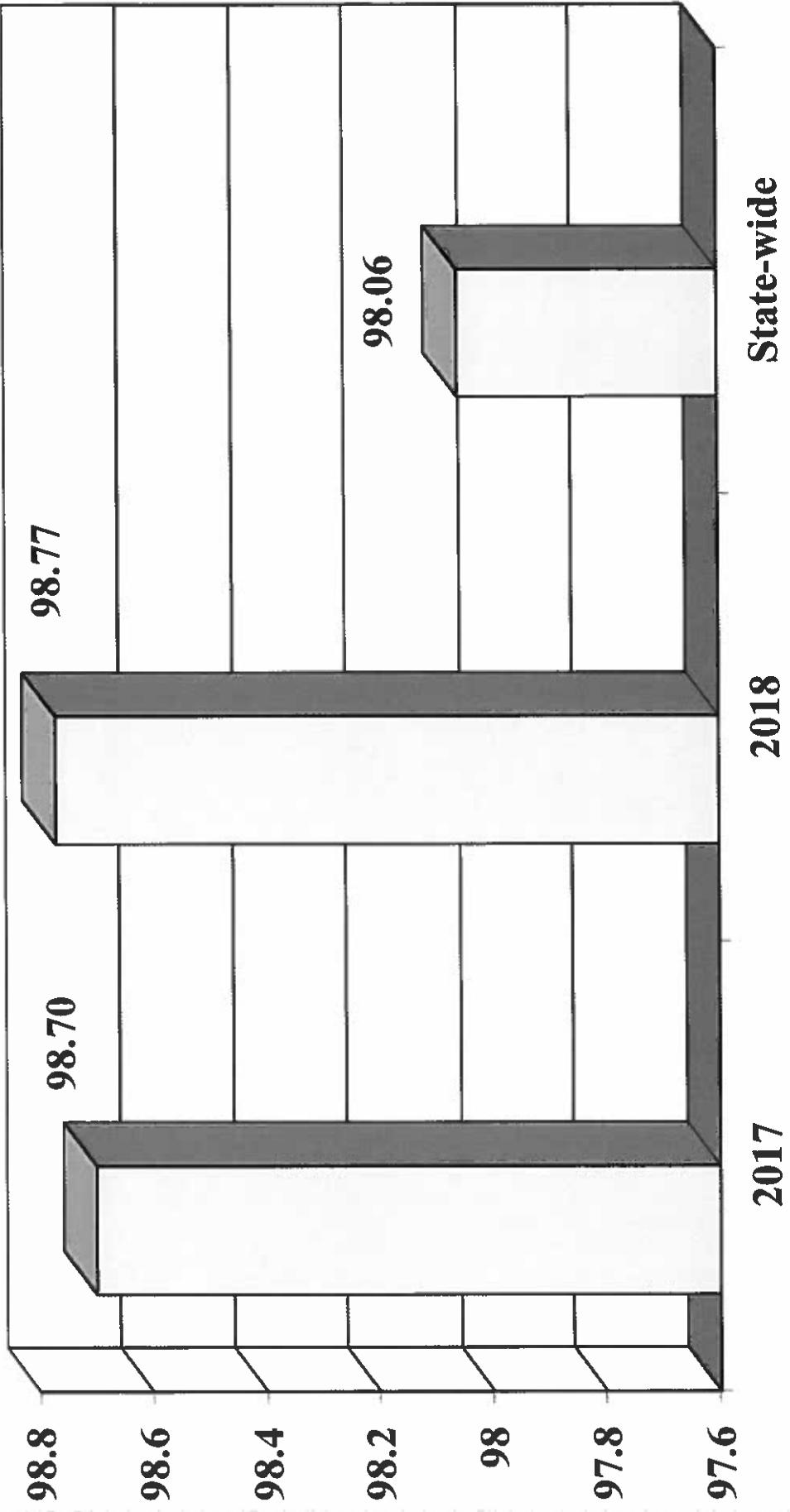

Proprietary Funds

	Enterprise Funds	
	2017	2018
Operating Revenues	\$ 13,697,286	\$ 14,594,751
Operating Expenses	<u>11,503,166</u>	<u>12,652,310</u>
Operating Income (Loss)	<u>2,194,120</u>	<u>1,942,310</u>
Non-operating Revenues/Expenses	(195,663)	(128,073)
Capital contributions	<u>978,677</u>	<u>2,227,039</u>
Change in net position	<u>\$ 2,977,134</u>	<u>\$ 4,341,276</u>



To Chuck, Jamie and the
rest of finance and
administration for all of
their help during our
audit.

Franklin County Commissioner's Agenda Information Sheet

Requested Meeting Date: February 4, 2019

of attachment (s) _____

Item Title (as it should appear on the agenda): Comprehensive Parks and Recreation Master Plan

Initiated by (Name, Job Title): Oliver Greene, Director, Franklin County Parks and Recreation

Board action proposed: None

Is a public hearing needed? No

Has this item been reviewed by the appropriate staff? Please note all that apply.

County Manager X County Attorney _____ Finance Director _____

Summary of Request:

Oliver Greene, Director, Franklin County Parks and Recreation, will provide the Board with an update on the Franklin County Comprehensive Parks and Recreation Master Plan process. A resident survey is currently being conducted throughout the county.

FOR OFFICE USE ONLY:

- APPROVED
- DENIED

ACTION: _____ DATE: _____

Franklin County Commissioner's Agenda Information Sheet

Requested Meeting Date:

of attachment (s) none

Item Title (as it should appear on the agenda): **Board of Health Re-Appointments**

Initiated by (Name, Job Title): **Scott LaVigne, Health Director**

Board action proposed: **Approval of Recommended Board of Health Re-Appointments.**

Is a public hearing needed? **No.**

Has this item been reviewed by the appropriate staff? Please note all that apply.

County Manager _____ County Attorney _____ Finance Director _____

Summary of Request: **At their 1/8/19 meeting, the Franklin County Board of Health reviewed and approved the reappointment of Dr. Cletus Simpson (Dentist) to a new 3-year term on the Board of Health (to finish 12/1/21) and Dr. Philip Meador (Physician) to a new 3-year term on the Board of Health (also to finish on 12/1/21).**

FOR OFFICE USE ONLY:

- APPROVED
- DENIED

ACTION: _____ DATE: _____

Kristen King

From: burst@emailmeform.com on behalf of Jerry Ellington <burst@emailmeform.com>
Sent: Monday, January 28, 2019 10:06 PM
To: Kristen King
Subject: FRANKLIN COUNTY CITIZEN PARTICIPATION APPLICATION: Board of Health

Follow Up Flag: Follow up
Flag Status: Flagged

I am interested in serving on the following Board or Commission*:

Board of Health

Name*: Jerry Ellington

Spouse Name: Cindy Ellington

Address*: Family Eye Center
216 N. Bickett Blvd Suite 6
Louisburg, NC 27549
United States

Home/Cell Phone*: 252-213-0427

Work Phone: 919-496-2071

Email: jerryellington@hotmail.com

How many years have you been a resident of Franklin County*:

0

Present Employer*: Family Eye Center

Job Title: Optometrist/Owner/President

Age Group: 35- 60

Current Civic / Community Participation:: Rotary Club of Henderson-President, Board Member North Carolina State Board of Examiners in Optometry

Please provide any pertinent information NC licensed Optometrist for over 26 years, practicing part-time in Louisburg my whole career. Served on consulting staff for Franklin Regional Medical Center from 1992 until its closure. Past president of the N.C Optometric Society 2011-2012. Current member of

which qualifies you for service on this Board or Commission:* the North Carolina State Board of Examiners in Optometry.
Former appointee to the Governor's Commission on Early Childhood Vision, Former member of NC Medicaid's Physician Advisory Group's Consulting Council

Education*: Doctorate in Optometry, Pennsylvania College of Optometry 1992, B.S in Zoology, N.C. State University 1988

Are you available throughout the year? (If answering No...Explain when available below.)*:

Yes

When Available:*

Immediately

If appointed, could you meet:*

Evenings

What Boards or Commissions are you currently serving on, if any?*

North Carolina State Board of Examiners in Optometry
North Carolina Optometric Foundation/Treasurer

Do you anticipate any conflicts of interest if appointed? If Yes, please explain:*

No